

Power switch on this corner

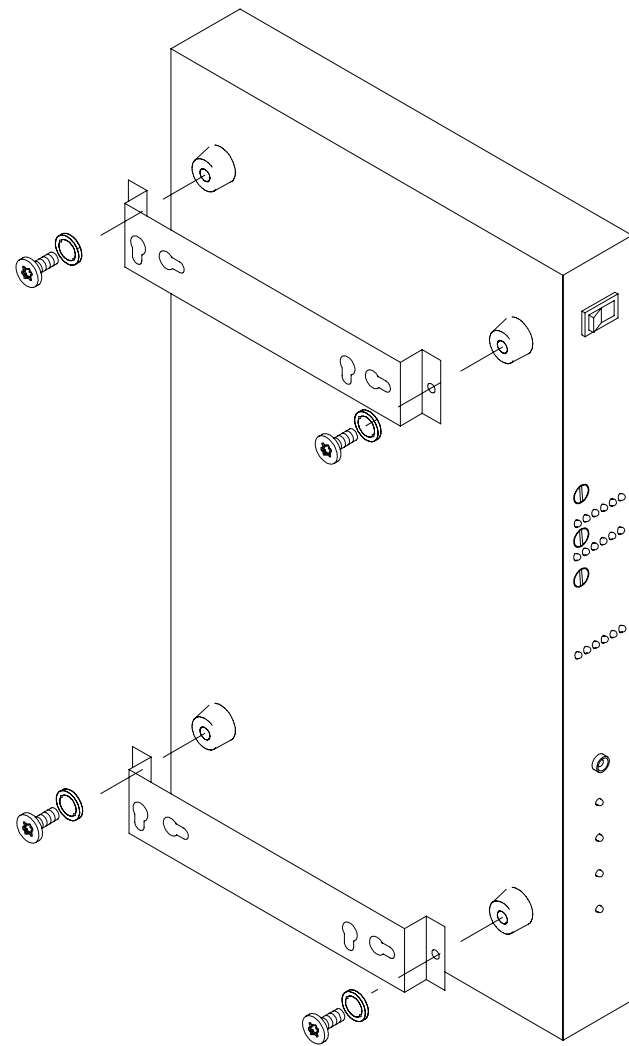
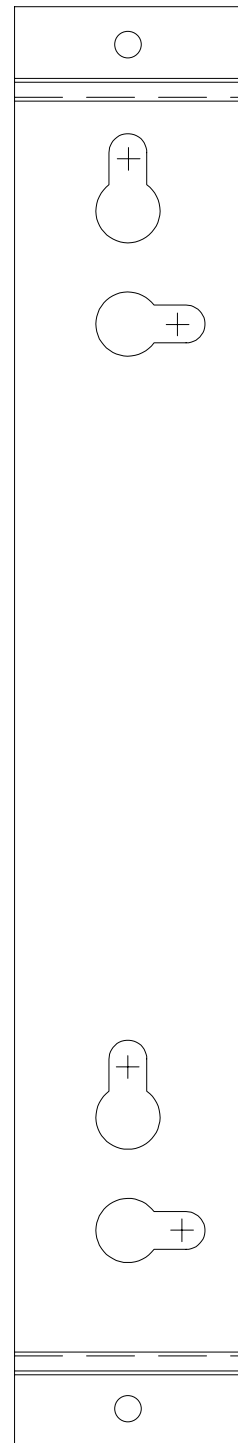

INSTRUCTIONS FOR FIXING TO THE WALL

DRILLING TEMPLATE

USE NO.8 ROUND HEAD SCREWS

UNIT MAY BE MOUNTED VERTICALLY
OR HORIZONTALLY

IMPORTANT

USE 4 WALL FASTENERS, EACH CAPABLE OF SUPPORTING
4.77kg / 10lb 8oz, TO PROVIDE A SAFETY FACTOR OF 4.
USE APPROPRIATE FIXINGS, PLUGS OR ANCHORS, FOR THE
TYPE OF WALL THE UNIT IS TO BE MOUNTED ON.

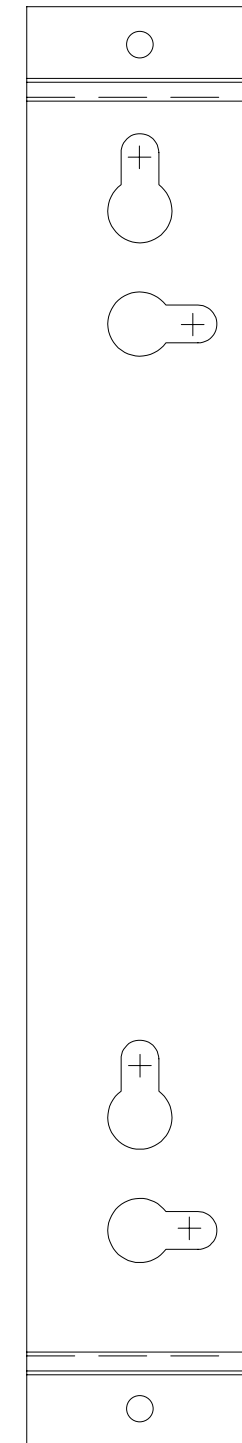

INSTRUCTIONS FOR FITTING THE WALL MOUNT BRACKETS

REMOVE ALL RUBBER FEET
ORIENTATE BRACKETS AS SHOWN
FIT BRACKETS TO UNIT USING SCREWS AND WASHERS SUPPLIED (4 off M3 x 6 Pan TORX)
DO NOT USE SCREWS USED TO FIT THE RUBBER FEET
TORX T10 DRIVER IS REQUIRED

UP47701-1